

# CTL806 C

## 02 Mini Canopy Mount LED Luminaire

### Specifications/Features

#### Fixture

High performance, small scale LED luminaire available in three (3) wattages:

- 10W (1100lm\*)
- 14W (1400lm\*)
- 20W (1800lm\*)

\*Lumen values are approximate, see page 3 for photometric test results.

Constructed of die-cast aluminum, the heat-sink and canopy housing provide a sleek modern look, designed to quietly compliment any space.

May be ceiling or wall mounted.

Dimming is available and allows smooth illumination down to 1% utilizing Lutron HiLume or Lutron EcoSystem driver option. For dimmer compatibility, refer to [Dimming Specifications sheet](#).

Lutron driver options require a larger canopy (5-3/4" Dia. x 1-1/2" Tall).

Lockable, precision aiming adjustment. 360°+ aiming horizontal rotation, 250° vertical rotation, 35° upward tilt (both directions).

Can accept up to (2) LF16 60MM lens or FA-16 60MM Black Honeycomb Louvers when used with the FA-43 Snoot / Accessory Holder, ordered separately.

Product weight: 1.5lbs.

#### Lamp/Electrical

Light engine consists of a single, high lumen output multi-chip LED array.

Available in the following color temperatures:

- 2700K; CRI 80 min., 83 Typical (High CRI 90+ available)
- 3000K; CRI 80 min., 83 Typical (High CRI 90+ available)
- 3500K; CRI 80 min., 83 Typical (High CRI 90+ available)
- 4000K; CRI 80 min., 83 Typical (High CRI 90+ available)
- 3000K; CRI 90+, Crisp White

The 3000K Crisp White LED delivers 90+ color rendering with additional violet wavelengths that enhance white visibility.

Excellent fixture-to-fixture color consistency within a 2-step MacAdam Ellipse tolerance.

Available in Spot (12°), Medium (28°) and Flood (39°) beam distributions.

Each molded TIR optic has been optically engineered to provide a smooth uniform beam, maximizing output and minimizing glare.

System designed and rated for 50,000 hours at 70% lumen maintenance.

#### Warranty

This complete fixture is covered by ConTech's full five (5) year replacement guarantee after date of purchase.

#### Listing

cCSAus Certified to UL standards. Suitable for damp locations.

10W High CRI series can be used to comply with 2016 Title 24, Part 6 high efficacy LED light source requirements.

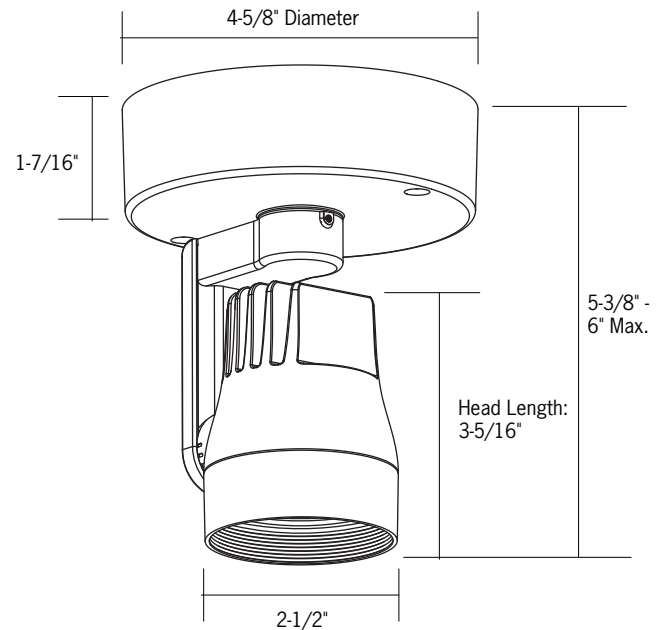

MVD Driver Canopy Option Shown

	8061	8062	8063
<b>Input Wattage (W)</b>	10	14	20
<b>Input Current (A) 120/277</b>	.09/.04	.13/.06	.20/.09
<b>Input Voltage</b>			
Dimming (Triac, ELV, 0-10V)	90-305V AC, 50/60Hz		
Lutron HiLume® Dimming	120V AC, 50/60Hz		
Lutron Eco-System® Dimming	120-277V AC, 50/60Hz		
<b>Color Temp</b>	2700K/3000K/3500K/4000K		
<b>CRI Standard/High</b>	83 (80min) / 90+		
<b>Driver</b>			
Power Factor	> 0.90		
THD	< 20%		
<b>Dimming</b>			
Triac, ELV, 0-10V	10-100%		
Lutron®	1-100%		

# CTL806 C

## 02 Mini Canopy Mount LED Luminaire

### Ordering Information

Example Order:  –

Fixture	Housing	Beam	Color Temp	Driver Option	Finish	Accessories
<b>CTL8061</b> - 10W/ 1100Lm <b>CTL8062</b> - 14W/ 1400Lm <b>CTL8063</b> - 20W/ 1800Lm	<b>C</b> - Mono-Point Canopy	<b>S</b> - 12° Spot <b>M</b> - 28° Medium <b>F</b> - 39° Flood	<b>27</b> - 2700K <b>3</b> - 3000K <b>35</b> - 3500K <b>4</b> - 4000K <b>27C</b> - 2700K, 90+ CRI <b>3C</b> - 3000K, 90+ CRI <b>35C</b> - 3500K, 90+ CRI <b>4C</b> - 4000K, 90+ CRI <b>3W</b> - 3000K, 90+ CRI, Crisp White	<b>MVD</b> - 120-277V Triac <sup>1</sup> , ELV, 0-10V Dimming <b>12D3</b> <sup>2</sup> - 120V Lutron Hi-lume 1% 2-Wire LED Driver (120V Forward Phase Only) <b>MVD4</b> <sup>2</sup> - 120V-277V Lutron Hi-lume 1% EcoSystem LED Driver with Soft-On, Fade-to-Black Dimming	<b>B</b> - Black <b>P</b> - White <b>S</b> - Silver	<b>2INOPTIC-S</b> - 2" TIR Optic, Spot Beam <b>2INOPTIC-M</b> - 2" TIR Optic, Medium Beam <b>2INOPTIC-F</b> - 2" TIR Optic, Flood Beam <b>5500011</b> - 2" Diffusion Disc <b>BD16A</b> - Barn Doors <b>FA-16 60MM</b> - 2-3/8" Dia. Black Honeycomb Louver <b>FA-43-(B,P,S)</b> - 1" Snoot/Accessory Holder <b>LF16-* 60MM</b> 2-3/8" Dia. Tempered Glass Lenses; Requires FA-43 Snoot/Accessory Holder

1. Triac Dimmable at 120V Only.  
2. Requires larger canopy (5-3/4" Dia. x 1-1/2" Tall).

<sup>\*</sup>Color/Pattern Legend  
**A** (Amber), **B** (Blue), **CL** (Clear), **G** (Green), **LB** (Light Blue),  
**R** (Red), **RO** (Rose), **Y** (Yellow), **73** (Spread Lens),  
**LS** (Linear Spread Lens), **SL** (Soft Light), **SOL** (Solite)

# CTL806 C

## 02 Mini Canopy Mount LED Luminaire

### Photometrics

Lumen output values fluctuate based on CCT and CRI. To estimate lumen output of the various CCT/CRI options, multiply 3000K (80 CRI min) results by the following:

CCT	Standard CRI	High CRI	Crisp White
2700K	.935	.703	N/A
3000K	N/A	.754	.787
3500K	1.0	.812	N/A
4000K	1.0	.87	N/A

For 14W data, multiply results by .78; For 10W data, multiply results by .59

### 20W Spot Beam, 3000K: CTL8063HS3D

Designed for 50,000 Hour Lamp Life<sup>1</sup>; LM-63 Test No. 86370

Light Output (Fixture Delivered Lumens): 1509  
 Total Watts@120V: 20.0; Lumens Per Watt: 75.5  
 Center Beam Candle Power: 17472  
 Color Rendering Index (CRI)<sup>2</sup>: 83  
 Color Temperature (CCT)<sup>3</sup>: 3131K  
 Spectral Power Distribution Chart<sup>4</sup>  
 LM-79 Test No. 86373

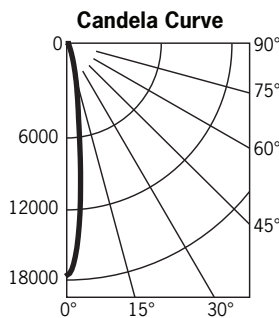
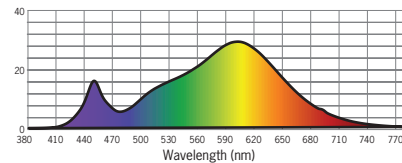

#### Candlepower Summary

FROM 0	CANDELA	LUMENS
0	17472	
5	10835	788
15	1738	501
25	232	123
35	43	30
45	27	21
55	20	18
65	16	15
75	8	9
85	4	4
95	0	

#### Intensity Distribution

DISTANCE (FT.)	FOOTCANDLES (FC)	BEAM DIAMETER (FT.)
4'	1092.0	0.8
6'	485.3	1.3
8'	273.0	1.7
10'	174.7	2.1
12'	121.3	2.5
14'	89.1	2.9

Beam Distribution: 12°  
 Spacing Criterion: 0.21

### 20W Medium Beam, 3000K: CTL8063HM3D

Designed for 50,000 Hour Lamp Life<sup>1</sup>; LM-63 Test No. 86371

Light Output (Fixture Delivered Lumens): 1852  
 Total Watts@120V: 20.3; Lumens Per Watt: 91.2  
 Center Beam Candle Power: 7634  
 Color Rendering Index (CRI)<sup>2</sup>: 83  
 Color Temperature (CCT)<sup>3</sup>: 3106K  
 Spectral Power Distribution Chart<sup>4</sup>  
 LM-79 Test No. 86374

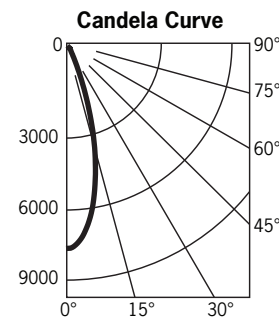
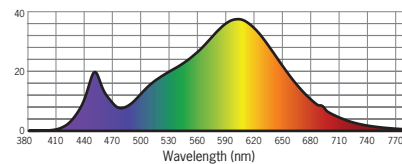

#### Candlepower Summary

FROM 0	CANDELA	LUMENS
0	7634	
5	7003	621
15	3524	931
25	366	235
35	68	46
45	15	12
55	4	4
65	2	2
75	1	1
85	0	0
95	0	

#### Intensity Distribution

DISTANCE (FT.)	FOOTCANDLES (FC)	BEAM DIAMETER (FT.)
4'	477.1	1.9
6'	212.1	2.9
8'	119.3	3.8
10'	76.3	4.8
12'	53.0	5.7
14'	38.9	6.7

Beam Distribution: 29°  
 Spacing Criterion: 0.46

### 20W Flood Beam, 3000K: CTL8063HF3D

Designed for 50,000 Hour Lamp Life<sup>1</sup>; LM-63 Test No. 86372

Light Output (Fixture Delivered Lumens): 1897  
 Total Watts@120V: 20.3; Lumens Per Watt: 93.4  
 Center Beam Candle Power: 4501  
 Color Rendering Index (CRI)<sup>2</sup>: 83  
 Color Temperature (CCT)<sup>3</sup>: 3114K  
 Spectral Power Distribution Chart<sup>4</sup>  
 LM-79 Test No. 86375

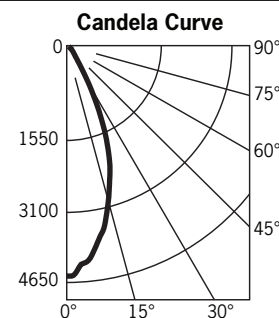
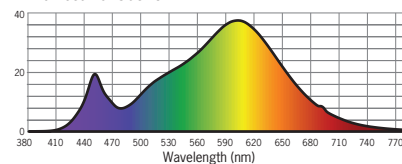

#### Candlepower Summary

FROM 0	CANDELA	LUMENS
0	4501	
5	4209	383
15	2951	817
25	1260	561
35	140	100
45	28	25
55	5	6
65	3	3
75	2	3
85	1	1
95	0	

#### Intensity Distribution

DISTANCE (FT.)	FOOTCANDLES (FC)	BEAM DIAMETER (FT.)
4'	281.3	2.5
6'	125.0	3.8
8'	70.3	5.1
10'	45.0	6.3
12'	31.3	7.6
14'	23.0	8.8

Beam Distribution: 39°  
 Spacing Criterion: 0.63

1. Dependent on surrounding temperatures  
 2. Accuracy of rendering colors  
 3. Color appearance of light source  
 4. Colors present within the light source