

CTL806 H

O2 Mini Horizontal Housing LED Track Fixture

Specifications/Features

Fixture

High performance, small scale LED track fixture available in three (3) wattages:

10W (1100lm*)

14W (1400lm*)

20W (1800lm*)

*Lumen values are approximate, see page 3 for photometric test results.

Constructed of die-cast aluminum, the heat-sink and driver housing provide a sleek modern look, designed to quietly compliment any space.

Dimming is standard for all wattage options and allows smooth illumination down to 10%. For dimmer compatibility, refer to [Dimming Specifications sheet](#).

Lockable, precision aiming adjustment. 360°+ aiming horizontal rotation, 250° vertical rotation, 35° upward tilt (both directions).

Integral ON/OFF switch and track polarity indicator are standard.

Can accept up to (2) LF16 60MM lens or FA-16 60MM Black Honeycomb Louvers when used with the FA-43 Snoot / Accessory Holder, ordered separately.

Lamp

Light engine consists of a single, high lumen output multi-chip LED array. Available in the following color temperatures:

2700K; CRI 80 min., 83 Typical (High CRI 90+ available)

3000K; CRI 80 min., 83 Typical (High CRI 90+ available)

3500K; CRI 80 min., 83 Typical (High CRI 90+ available)

4000K; CRI 80 min., 83 Typical (High CRI 90+ available)

3000K; CRI 90+, Crisp White

The 3000K Crisp White LED delivers 90+ color rendering with additional violet wavelengths that enhance white visibility.

Excellent fixture-to-fixture color consistency within a 2-step MacAdam Ellipse tolerance.

Available in Spot (12°), Medium (28°) and Flood (39°) beam distributions. Each molded TIR optic has been optically engineered to provide a smooth uniform beam, maximizing output and minimizing glare.

System designed and rated for 50,000 hours at 70% lumen maintenance.

Electrical

10W Driver Specifications: Input Wattage 10W; Output Current 250mA

Input Voltage: 120VAC

Dimming: Leading Edge (Incandescent) or Trailing Edge (ELV)

14W Driver Specifications: Input Wattage 14W; Output Current 350mA

Input Voltage: 120VAC

Dimming: Leading Edge (Incandescent) or Trailing Edge (ELV)

20W Driver Specifications: Input Wattage 20W; Output Current 500mA

Input Voltage: 120VAC

Dimming: Leading Edge (Incandescent) or Trailing Edge (ELV)

Warranty

This complete fixture is covered by ConTech's full five (5) year replacement guarantee after date of purchase.

Listing

cCSAus Certified to UL standards. Suitable for dry locations.

Energy Star Approved for all fixture variations except Crisp White.

DLC Listed for all models except Crisp White.

10W High CRI series can be used to comply with 2016 Title 24, Part 6 high efficacy LED light source requirements.

Fixture Compatibility

Standard ConTech track fixtures are cCSAus certified as-is for use with ConTech's many track systems, as well as with Juno^{®1} Lighting track. By changing the prefix in the part number, ConTech can install inserts which make our fixtures compatible with other manufacturers. Replace "CTL" with "HTL" for Halo^{®2} track, "LTL" for Lightolier^{®3} track, and "PTL" for Capri^{®4} track. For more information, please consult our factory.

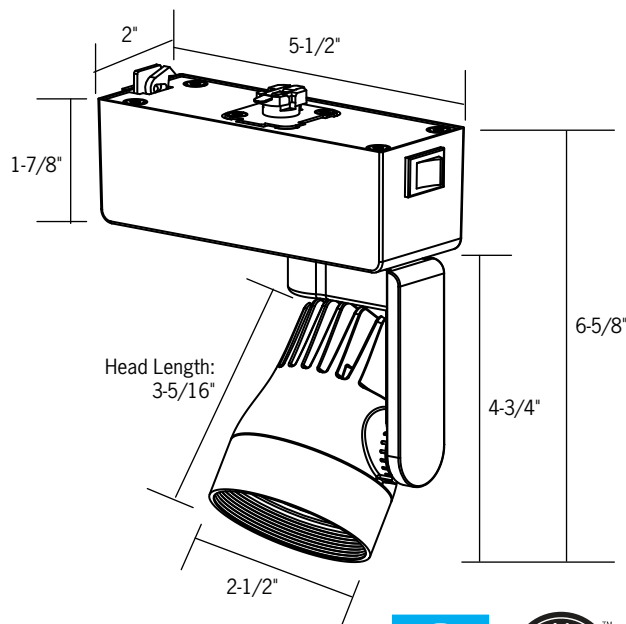

1. Juno is a registered trademark of Juno Lighting
 2. Halo is a registered trademark of Cooper Lighting
 3. Lightolier is a registered trademark of Philips Lighting
 4. Capri is a registered trademark of Philips Lighting

CTL806 H

02 Mini Horizontal Housing LED Track Fixture

Ordering Information

Example Order: -

Track System	Fixture	Orientation	Beam	Color Temp	Dimming Option	Finish	Accessories
<input type="text"/>	<input type="text"/>	<input type="text"/>	<input type="text"/>	<input type="text"/>	<input type="text"/>	<input type="text"/>	<input type="text"/>
CTL - ConTech HTL - Halo LTL - Lightolier PTL - Capri	8061 - 10W/ 1100Lm 8062 - 14W/ 1400Lm 8063 - 20W/1800Lm	H - Horizontal	S - Spot M - Medium F - Flood	27 - 2700K 3 - 3000K 35 - 3500K 4 - 4000K 27C - 2700K, 90+ CRI 3C - 3000K, 90+ CRI 35C - 3500K, 90+ CRI 4C - 4000K, 90+ CRI 3W - 3000K, 90+ CRI, Crisp White	D - Dimming	B - Black P - White S - Silver	2INOPTIC-S - 2" TIR Optic, Spot Beam 2INOPTIC-M - 2" TIR Optic, Medium Beam 2INOPTIC-F - 2" TIR Optic, Flood Beam 5500011 - 2" Diffusion Disc BD16A - Barn Doors FA-16 60MM - 2-3/8" Dia. Black Honeycomb Louver FA-43-(B,P,S) - 1" Snoot/Accessory Holder LF16-* 60MM 2-3/8" Dia. Tempered Glass Lenses; Requires FA-43 Snoot/Accessory Holder

**Color/Pattern Legend*
 -A (Amber), -B (Blue), -CL (Clear), -G (Green), -LB (Light Blue),
 -R (Red), -RO (Rose), -Y (Yellow), -73 (Spread Lens),
 -LS (Linear Spread Lens), -SL (Soft Light), -SOL (Solite),
 -UV (Optivex UV Filter)

CTL806 H

O2 Mini Horizontal Housing LED Track Fixture

Photometrics

Lumen output values fluctuate based on CCT and CRI. To estimate lumen output of the various CCT/CRI options, multiply 3000K (80 CRI min) results by the following:

CCT	Standard CRI	High CRI	Crisp White
2700K	.935	.703	N/A
3000K	N/A	.754	.787
3500K	1.0	.812	N/A
4000K	1.0	.87	N/A

For 14W data, multiply results by .78; For 10W data, multiply results by .59

20W Spot Beam, 3000K: CTL8063HS3D

Designed for 50,000 Hour Lamp Life¹; LM-63 Test No. 86370

Light Output (Fixture Delivered Lumens): 1509
Total Watts@120V: 20.0; **Lumens Per Watt:** 75.5
Center Beam Candle Power: 17472
Color Rendering Index (CRI)²: 83
Color Temperature (CCT)³: 3131K
Spectral Power Distribution Chart⁴
 LM-79 Test No. 86373

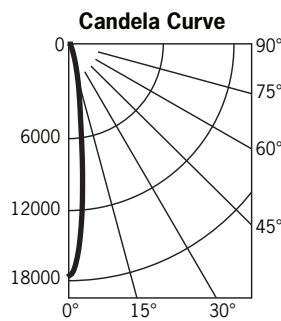
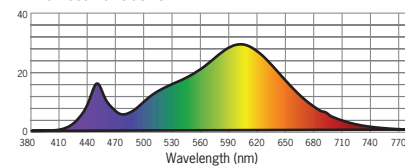

FROM 0	CANDELA	LUMENS
0	17472	
5	10835	788
15	1738	501
25	232	123
35	43	30
45	27	21
55	20	18
65	16	15
75	8	9
85	4	4
95	0	

DISTANCE (FT.)	FOOTCANDLES (FC)	BEAM DIAMETER (FT.)
4'	1092.0	0.8
6'	485.3	1.3
8'	273.0	1.7
10'	174.7	2.1
12'	121.3	2.5
14'	89.1	2.9

Beam Distribution: 12°
Spacing Criterion: 0.21

20W Medium Beam, 3000K: CTL8063HM3D

Designed for 50,000 Hour Lamp Life¹; LM-63 Test No. 86371

Light Output (Fixture Delivered Lumens): 1852
Total Watts@120V: 20.3; **Lumens Per Watt:** 91.2
Center Beam Candle Power: 7634
Color Rendering Index (CRI)²: 83
Color Temperature (CCT)³: 3106K
Spectral Power Distribution Chart⁴
 LM-79 Test No. 86374

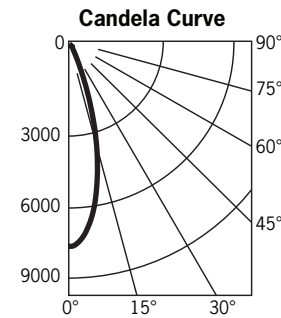
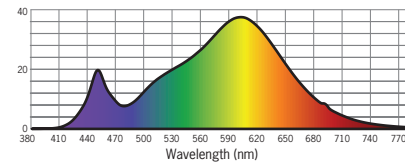

FROM 0	CANDELA	LUMENS
0	7634	
5	7003	621
15	3524	931
25	366	235
35	68	46
45	15	12
55	4	4
65	2	2
75	1	1
85	0	0
95	0	

DISTANCE (FT.)	FOOTCANDLES (FC)	BEAM DIAMETER (FT.)
4'	477.1	1.9
6'	212.1	2.9
8'	119.3	3.8
10'	76.3	4.8
12'	53.0	5.7
14'	38.9	6.7

Beam Distribution: 29°
Spacing Criterion: 0.46

20W Flood Beam, 3000K: CTL8063HF3D

Designed for 50,000 Hour Lamp Life¹; LM-63 Test No. 86372

Light Output (Fixture Delivered Lumens): 1897
Total Watts@120V: 20.3; **Lumens Per Watt:** 93.4
Center Beam Candle Power: 4501
Color Rendering Index (CRI)²: 83
Color Temperature (CCT)³: 3114K
Spectral Power Distribution Chart⁴
 LM-79 Test No. 86375

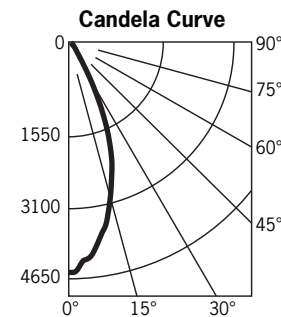
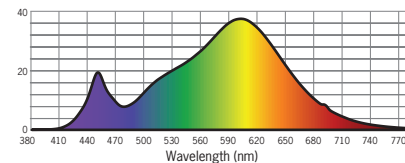

FROM 0	CANDELA	LUMENS
0	4501	
5	4209	383
15	2951	817
25	1260	561
35	140	100
45	28	25
55	5	6
65	3	3
75	2	3
85	1	1
95	0	

DISTANCE (FT.)	FOOTCANDLES (FC)	BEAM DIAMETER (FT.)
4'	281.3	2.5
6'	125.0	3.8
8'	70.3	5.1
10'	45.0	6.3
12'	31.3	7.6
14'	23.0	8.8

Beam Distribution: 39°
Spacing Criterion: 0.63

1. Dependent on surrounding temperatures
 2. Accuracy of rendering colors
 3. Color appearance of light source
 4. Colors present within the light source