

R4ZNE20

4" Universal New Construction Recessed Downlight with Megaman BR20/PAR20 E26 Base LED Lamp

Specifications/Features

Housing/Mounting

Compact 4" incandescent downlight housing for new construction applications; may be used with drywall, plaster or suspended ceilings, 1/2" to 1-1/2" thick.

The standard new construction housing may be used in insulated ceilings if a minimum 3" distance is maintained all around fixture from insulation material.

Nailer bar hangers included for easy installation, integral holding spikes for convenient mounting.

Dual extension bars adjustable for 16" and 24" center joists.

Hanger bars may be extended to rest on T-bar ceilings. Optional clip-on T-bar hangers are also available.

Input Voltage: 120V AC, 60Hz.

Prewired junction box with spring-latch access plates.

Approved for through-circuit wiring. Max (8) #12 AWG (4-in/4-out).

Adjustable lamp socket – vertical position.

Thermally protected.

Junction box has (6) 1/2" pry-outs, (1) 3/4" concentric pry-out and (4) Romex pry-outs.

Quick connect, push-in wire connectors included.

Dimming

Dimmable to 10% with forward phase/TRIAC dimming. For optimal performance, use forward phase/TRIAC dimmer specifically designed for LED lamps. Dimming performance may vary due to field conditions, including but not limited to, power quality, installation and wiring, and variations in dimmer production. Please reference the dimmer manufacturer's instructions for dimmer installation and further information.

Trims

Many different trims options are available to complement any design style.

Warranty

This fixture is covered by ConTech's full three (3) year replacement guarantee after date of purchase.

Listing

cCSAus Certified. Suitable for damp locations.

BR20 and 30-degree PAR20 lamps are Energy Star listed as noted.

Light Output/Performance

Megaman LED lamp designed to last 25,000 hours

Correlated Color Temperature of 2700K, 3000K, or 3500K; Color Rendering Index of 82

Correlated Color Temperature of 4000K, Color Rendering Index of 85
RoHS compliant, contains no lead or mercury.

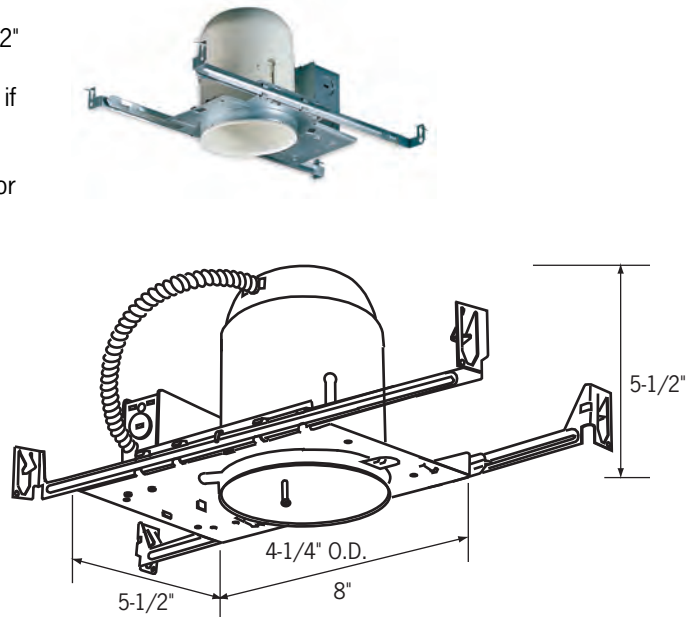

Ceiling Opening: 4-3/4"
Plaster Frame: 8" x 5-1/2"

Lamp Type	Lumens	CBCP	Base	CCT	W	LPW
BR20	600		E26	2700K, 3000K 3500K, 4000K	9.5W	63LpW
PAR20 30 Degree	600	900	E26	2700K, 3000K 3500K, 4000K	7W	86LpW
PAR20 15 Degree	650	5500	E26	2700K, 3000K 3500K, 4000K	10W	65LpW
PAR20 35 Degree	900	1800	E26	2700K, 3000K 3500K, 4000K	10W	90LpW



BR20



PAR20
30-Degree



PAR20
15-Degree



PAR20
35-Degree

R4ZNE20

4" Universal New Construction Recessed Downlight with Megaman BR20/PAR20 E26 Base LED Lamp

Trims

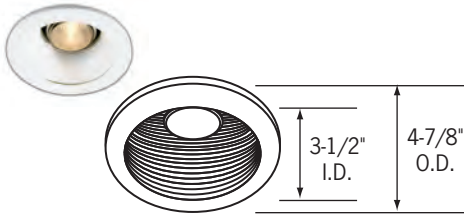

CTR2001-P
 Black Baffled Downlight
CTR2001W-P
 White Baffled Downlight

All steel construction. (3) heat treated spring steel mounting clips. Black socket aiming bracket with screws (provided in carton).

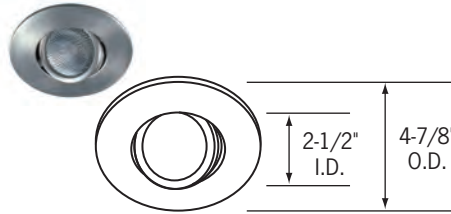

CTR2007-(P, B, NK)
 Surface Adjustable
 28° vertical adjustment. All steel construction. (3) heat treated spring steel mounting clips. Lamp retaining sweep spring clip. **PAR20 Lamp only.**

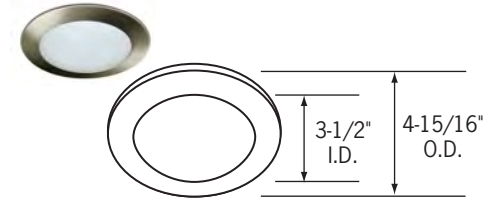

CTR2011FR-(NK, P)
 Flat Frosted Glass Lens Shower Light
 All steel construction. (3) heat treated spring steel mounting clips. 1/8" thick heavy duty polyethylene sponge gasket. Wet location listed.

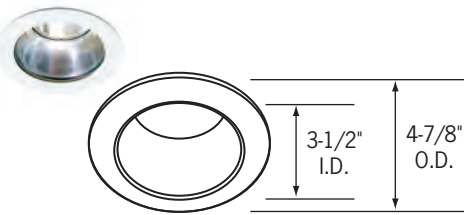

CTR2002-BLK-B
 Black Specular Aluminum Reflector, Black Trim

CTR2002-CLR-P
 Clear Specular Aluminum Reflector

CTR2002-WHT-P
 White Specular Aluminum Reflector

All steel construction. (3) heat treated spring steel mounting clips. Black socket aiming bracket with screws (provided in carton).

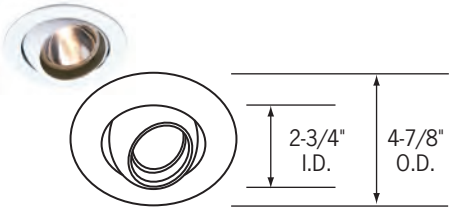

CTR2008-P
 Eyeball
 30° vertical adjustment. All steel construction. (3) heat treated spring steel mounting clips.

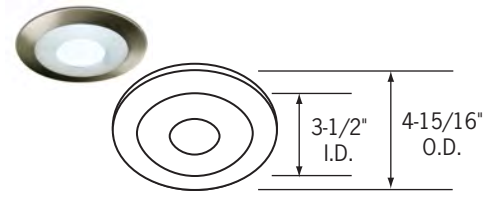

CTR2011-PH-(NK, P)
 Flat Frosted Glass Lens Shower Light with Clear Pin Hole
 All steel construction. (3) heat treated spring steel mounting clips. 1/8" thick heavy duty polyethylene sponge gasket. Wet location listed.

Ordering Information

Example Order: -

Housing	Lamp	Trim	Options
<input type="text"/>	<input type="text"/>	<input type="text"/>	<input type="text"/>

R4ZNE20

- ML06D-BR27K - 9.5W BR20, 2700K
- ML06D-BR30K - 9.5W BR20, 3000K
- ML06D-BR35K - 9.5W BR20, 3500K
- ML06D-BR40K - 9.5W BR20, 4000K
- ML06D-3027K - 7W PAR20, 30°, 2700K
- ML06D-3030K - 7W PAR20, 30°, 3000K
- ML06D-3035K - 7W PAR20, 30°, 3500K
- ML06D-3040K - 7W PAR20, 30°, 4000K
- ML09D-3527K - 10W PAR20, 35°, 2700K
- ML09D-3530K - 10W PAR20, 35°, 3000K
- ML09D-3535K - 10W PAR20, 35°, 3500K
- ML09D-3540K - 10W PAR20, 35°, 4000K
- ML06D-1527K - 10W PAR20, 15°, 2700K
- ML06D-1530K - 10W PAR20, 15°, 3000K
- ML06D-1535K - 10W PAR20, 15°, 3500K
- ML06D-1540K - 10W PAR20, 15°, 4000K

- CP - Chicago Plenum
- HB-20 - 20" T-Bar Hanger Set
- HB-30 - 30" T-Bar Hanger Set