

RL20SA

4" LED New Construction StopAire® Non-IC Recessed Downlight

Specifications/Features

Housing/Mounting

Performance LED fixture delivering up to 1200 lumens in a smooth wide beam.

Requires minimum 3" clearance around fixture from insulation material. Thermal protection provided in case of improper insulation use.

Aluminum housing with galvanized steel mounting frame.

Dual Extension bars adjustable for 16" and 24" center joists (14-1/4" – 24-1/2").

Nailer bar hangers feature a locking screw to secure housing in desired location along bar hangers. Hanger bars may be extended to rest on T-bar ceilings. Optional clip-on T-bar hangers also available.

Electrical

UL8750 and Class 2 Compliant, RoHS Compliant.

Output over-voltage, over-current and short circuit protection.

Prewired junction box with convenient screwdriver pry-outs: (6) 1/2", (1) 1/2"x3/4" concentric and (4) Romex pryouts. Spring-latch access plates. Quick-connect push-in wire connectors provided.

Approved for through-circuit wiring. Max: (8) #12 AWG (4 in/4 out).

Wiring should be rated for at least 90°C.

Lamp

Light engine consists of a single, high output multi-chip LED array enabling precise optical control. Excellent fixture-to-fixture color consistency with a 3-step MacAdam Ellipse tolerance.

Precisely engineered optical system consists of an engineered plastic optical housing, aluminum reflector, and highly transmissive diffusion lens. The system provides a smooth uniform beam while eliminating view of LED array. A medium flood distribution is provided as standard; a flood optical system accessory is available. System designed and rated for 50,000 hours at 70% lumen maintenance

Dimming

All RL20 LED downlights are available for non-dimming and dimming applications. For a list of compatible dimmers, refer to [LED Dimming Catalog](#).

Trims

Many trim options available to complement any design style. See attached trim spec sheet for information and details.

Warranty

This complete fixture is covered by ConTech's full five (5) year replacement guarantee after date of purchase.

Emergency Battery option is covered by a one (1) year replacement guarantee after date of purchase.

Listing

cCSAus Certified to UL Standards. Suitable for damp locations.

Conforms to Washington State Energy code (WSEC) for low air infiltration. Tested in accordance with ASTM E283 (2.0 CRM or less).

Assembled in the USA.

Energy Star certified:

- Series 1 and 2 only.
- All CCT's except 27KC.
- Certified trims only: CTR2001W-P, CTR2002-(CLR-P, PL-P, WHT-P).
- Lutron dimming options are not Energy Star certified.

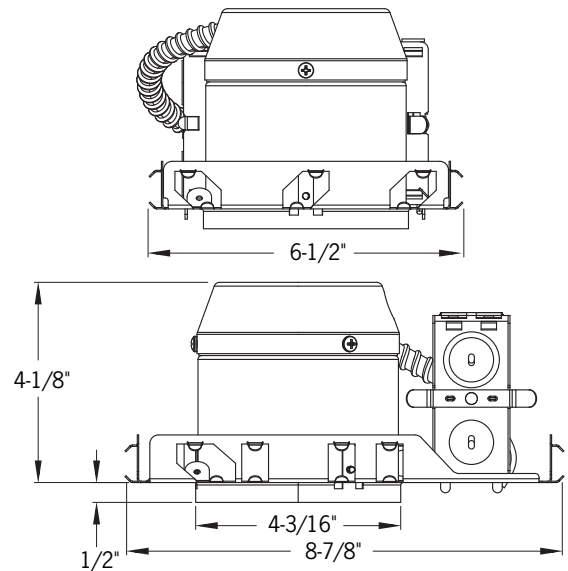

Ceiling Opening: 4-3/8"
Ceiling Thickness: 1/2" – 1-1/2"

	Series 1	Series 2	Series 3
Input Wattage (W)	12	17	23
Input Current (A) 120/277	.10/.04	.14/.06	.19/.08
Input Voltage			
120V Dimming (Triac, ELV, 0-10V)	120V AC, 50/60Hz		
277V Dimming (0-10V)	277V AC, 50/60Hz		
Lutron HiLume® Dimming	120V AC, 50/60Hz		
Lutron EcoSystem® Dimming	120V AC, 50/60Hz 277V AC, 50/60Hz		
Color Temp	2700K/3000K/3500K/4000K		
CRI	90+		
Driver			
Power Factor	> 0.90		
THD	< 20%		
Dimming			
Triac, ELV, 0-10V	10-100%		
Lutron®	1-100%		

RL20SA

4" LED New Construction StopAire® Non-IC Recessed Downlight

Ordering Information

Example Order: -

Housing	LED Series	Color Temp/CRI	Electrical	Dimming	Options
<input type="text"/>	<input type="text"/>	<input type="text"/>	<input type="text"/>	<input type="text"/>	<input type="text"/>
RL20SA	1 - 11W, 700lm 2 - 17W, 900lm 3 - 23W, 1200lm	27KC - 2700K 90+ CRI 30KC - 3000K 90+ CRI 35KC - 3500K 90+ CRI 40KC - 4000K 90+ CRI	12 - 120V 27 - 277V	D1 - TRIAC, ELV, 0-10V Dimming D3² - Hi-Lume 1% 2-Wire LED Driver (120V Forward Phase Only) D4 - Hi-Lume 1% EcoSystem LED Driver with Soft-on, Fade-to-Black	CP³ - Chicago Plenum ER⁴ - Factory Installed 7W/200mA Emergency Battery Backup [Remote Test Switch]

Accessories

- MGOPT4-FL** - Flood Optic
- HB-20** - 20" T-Bar Hanger Set
- HB-30** - 30" T-Bar Hanger Set

1. TRIAC and ELV Dimming for 120V only.

2. Lutron Hi-Lume dimming only available in 120V.

3. Chicago Plenum option is not available with D3 or D4 dimming. Chicago Plenum option cannot be used with Emergency Battery Backup option.

4. Emergency Battery Backup option: 460 Lumen nominal average for either Series 1, 2, or 3

Trims for RL20 LED Recessed Downlights

All trims have matte white trim finish unless specified.

All trims are suitable for damp locations; only shower trims are listed for wet locations.

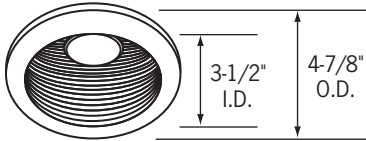

CTR2001-P
Black Baffled Downlight

CTR2001W-P

White Baffled Downlight
All steel construction. (3) heat treated spring steel mounting clips. Black socket aiming bracket with screws (provided in carton).

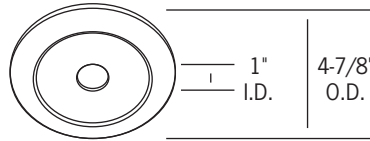

CTR2005-P
Pin Spot

All steel construction. (3) heat treated spring steel mounting clips. Black socket aiming bracket with screws (provided in carton). Aluminum reflector.

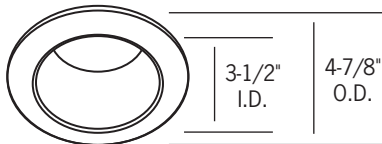

CTR2002-BLK-B
Black Specular Aluminum Reflector, Black Trim

CTR2002-CLR-P
Clear Specular Aluminum Reflector

CTR2002-PL-P
Platinum Aluminum Reflector

CTR2002-WHT-P
White Specular Aluminum Reflector

All steel construction. (3) heat treated spring steel mounting clips. Black socket aiming bracket with screws (provided in carton).

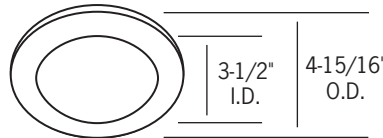

CTR2011FR-(NK, P)
Flat Frosted Glass Lens Shower Light
All steel construction. (3) heat treated spring steel mounting clips. 1/8" thick heavy duty polyethylene sponge gasket. Wet location listed.

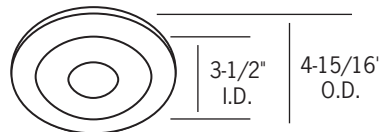

CTR2011-PH-(NK, P)
Flat Frosted Glass Lens Shower Light with Clear Pin Hole
All steel construction. (3) heat treated spring steel mounting clips. 1/8" thick heavy duty polyethylene sponge gasket. Wet location listed.

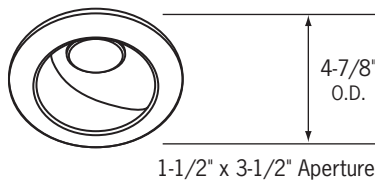

CTR2003-P
Scoop Wall Wash
All steel construction. (3) heat treated spring steel mounting clips. Black socket aiming bracket with screws (provided in carton).

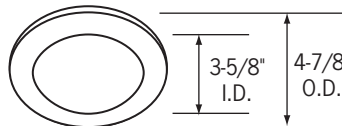

CTR2012-P
Flat Alabite Glass Lens Shower Light
All steel construction. (3) heat treated spring steel mounting clips. 1/8" thick heavy duty polyethylene sponge gasket. Wet location listed.

Reflector/Trim Finishes

Reflector Finish Options:

BLK - Black **PL** - Platinum
CLR - Clear **WHT** - White

Trim Finish Codes:

B - Black **P** - Matte White
NK - Brushed Nickel

RL20SA

4" LED New Construction StopAire® Non-IC Recessed Downlight

Photometrics

Multiplication Factors

CCT	CRI	SERIES 1	SERIES 2
2700K	0.9	0.56	0.74
3000K	N/A	0.56	0.74
3500K	1.0	0.56	0.74
4000K	1.0	0.56	0.74

RL20SA330KC12D/CTR2001W-P

Designed for 50,000 Hour Lamp Life¹; LM-63 Test No. G17011604

Light Output (Fixture Delivered Lumens): 1131
 Total Watts@120V: 22.8; Lumens Per Watt: 49.6
 Center Beam Candle Power: 1450
 Color Rendering Index (CRI)²: 90
 Color Temperature (CCT)³: 3065K
 Spectral Power Distribution Chart⁴

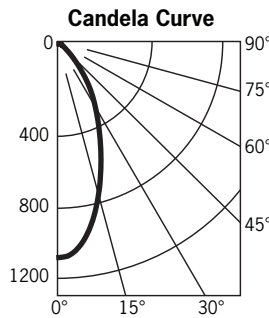
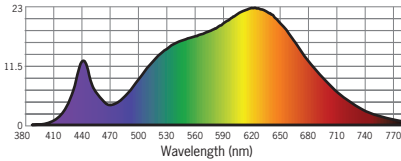

Candlepower Summary

FROM 0	CANDELA	LUMENS
0	1450	
5	1398	142
15	1065	302
25	677	313
35	295	185
45	121	94
55	60	54
65	38	38
75	18	19
85	4	2
95	0	

Intensity Distribution

DISTANCE (FT.)	FOOTCANDLES (FC)	BEAM DIAMETER (FT.)
4'	90.6	3.5
6'	40.3	5.3
8'	22.7	7.1
10'	14.5	8.8
12'	10.1	10.6
14'	7.4	12.4

Beam Distribution: 48°
 Spacing Criterion: 0.77

RL20SA330KC12D/CTR2002-CLR-P

Designed for 50,000 Hour Lamp Life¹; LM-63 Test No. G17011612

Light Output (Fixture Delivered Lumens): 1221
 Total Watts@120V: 22.8; Lumens Per Watt: 53.5
 Center Beam Candle Power: 2304
 Color Rendering Index (CRI)²: 90
 Color Temperature (CCT)³: 3048K
 Spectral Power Distribution Chart⁴

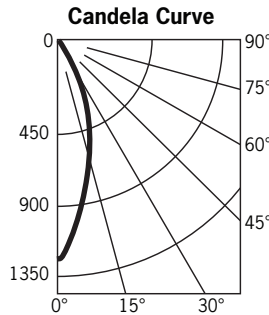
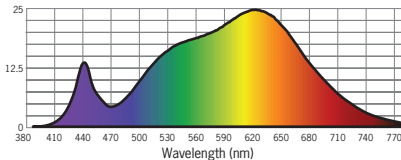

Candlepower Summary

FROM 0	CANDELA	LUMENS
0	2304	
5	2017	206
15	1305	370
25	777	360
35	314	198
45	106	82
55	29	26
65	5	5
75	3	3
85	2	1
95	0	

Intensity Distribution

DISTANCE (FT.)	FOOTCANDLES (FC)	BEAM DIAMETER (FT.)
4'	144.0	2.5
6'	64.0	3.8
8'	36.0	5.1
10'	23.0	6.3
12'	16.0	7.6
14'	11.8	8.8

Beam Distribution: 35°
 Spacing Criterion: 0.66

RL20SA330KC12D/CTR2002-PL-P

Designed for 50,000 Hour Lamp Life¹; LM-63 Test No. G17011601

Light Output (Fixture Delivered Lumens): 1155
 Total Watts@120V: 22.8; Lumens Per Watt: 50.7
 Center Beam Candle Power: 1686
 Color Rendering Index (CRI)²: 90
 Color Temperature (CCT)³: 3035K
 Spectral Power Distribution Chart⁴

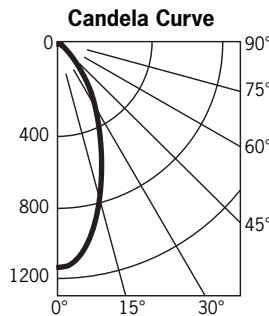
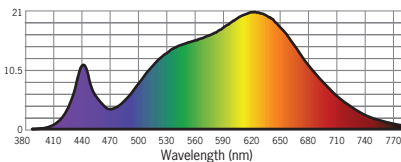

Candlepower Summary

FROM 0	CANDELA	LUMENS
0	1686	
5	1596	162
15	1171	332
25	742	343
35	320	201
45	117	90
55	36	32
65	10	10
75	5	5
85	3	2
95	0	

Intensity Distribution

DISTANCE (FT.)	FOOTCANDLES (FC)	BEAM DIAMETER (FT.)
4'	105.4	3.3
6'	46.8	5.0
8'	26.3	6.7
10'	16.9	8.3
12'	11.7	10.0
14'	8.6	11.7

Beam Distribution: 45°
 Spacing Criterion: 0.75

1. Dependent on surrounding temperatures, 2. Accuracy of rendering colors, 3. Color appearance of light source, 4. Colors present within the light source